



Even bijpraten....

Auteur Jan Bartling, Martine Kramer, Remco Rutten
Datum 5 februari 2016



saMBO-ICT

Kennisnet

Inhoud

1. Aansluiten bij SURF - Remco
2. Ict-monitor MBO - Martine
3. Informatiebeveiliging en privacy (IBP) - Jan
4. Kubus - Remco
5. MBO cloud - Remco
6. Model Onderwijsaanbod - Jan
7. Modernisering BPV Keten - Jan
8. Vakmanschap in de 21^e eeuw – Martine
9. VR in het mbo

Go to www.govote.at and use the code **27 78 18**

Go to www.govote.at and use the code **27 78 18**

Waar wil je nu meer over weten?

saMBO-ICT

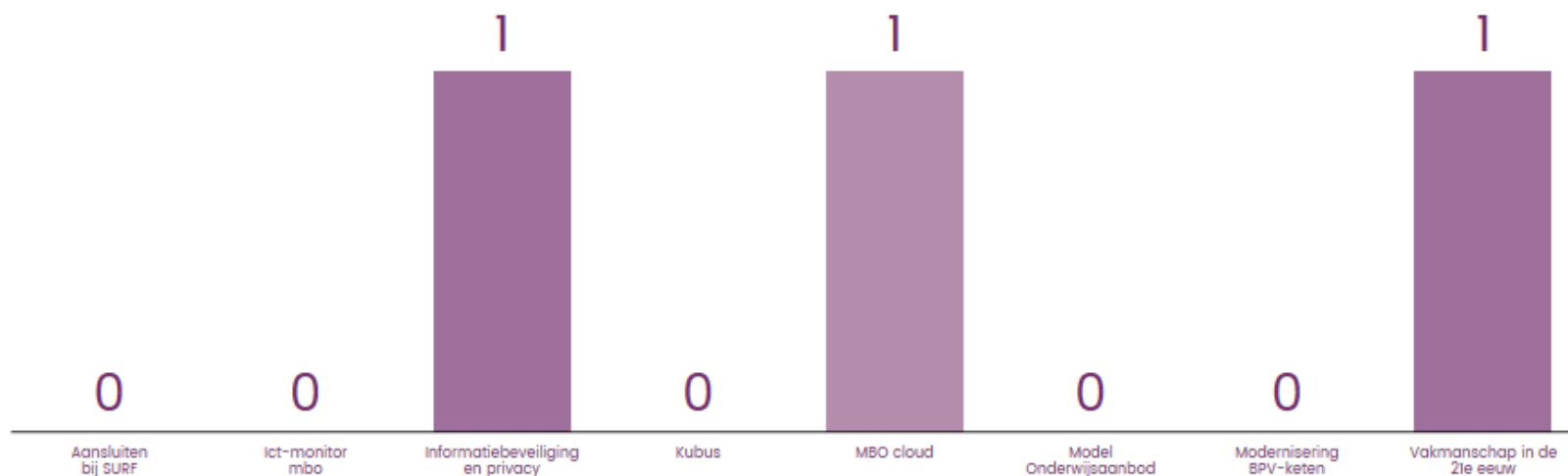

This question is not active [Activate question](#)

Votes: 1

1. Aansluiten bij SURF



Go to www.govote.at and use the code **27 78 18**

Als je instelling diensten afneemt bij SURFnet ben je dus ook lid van de Vereniging SURF

saMBO-ICT

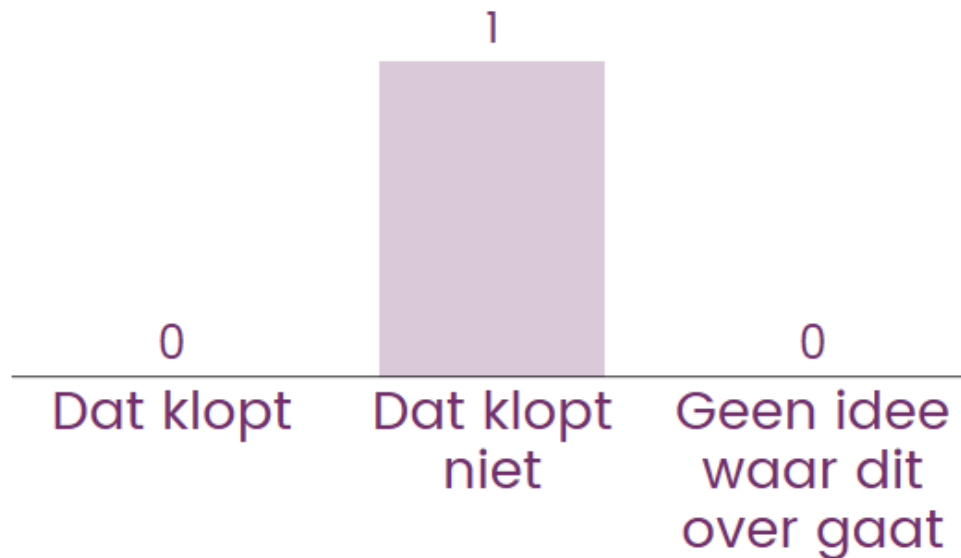

This question is not active [Activate question](#)

Votes: 1

Meer weten ? <https://www.surf.nl/over-surf/organisatie-en-bestuur/cooperatie-surf/index.html>

1. Aansluiten bij SURF



Go to www.govote.at and use the code **27 78 18**

Als je instelling diensten afneemt bij SURFnet ben je dus ook lid van de Vereniging SURF

saMBO-ICT

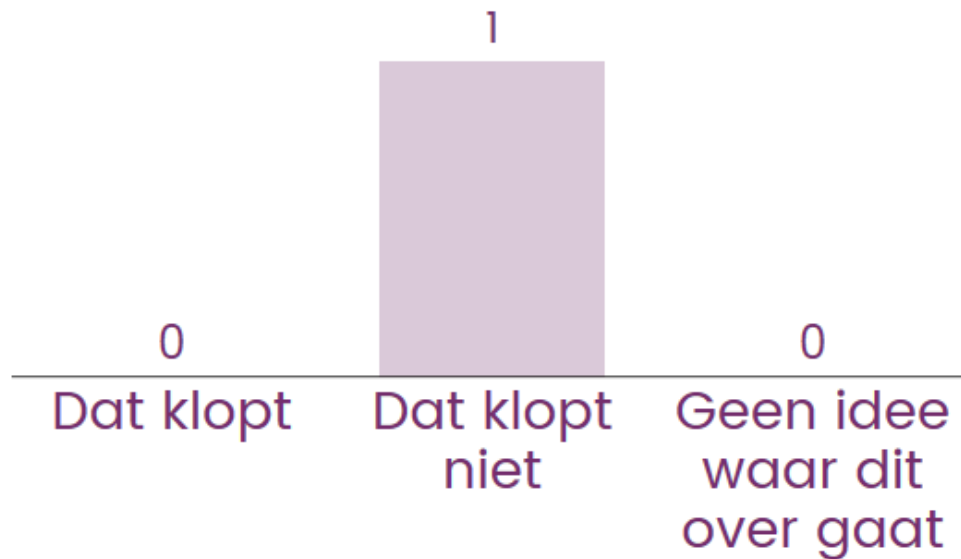

This question is not active [Activate question](#)

Votes: 1

Meer weten ? <https://www.surf.nl/over-surf/organisatie-en-bestuur/cooperatie-surf/index.html>

2. ICT Monitor



Go to www.govote.at and use the code **27 78 18**

Hoeveel instellingen hebben meegedaan aan de Ict-monitor mbo?

saMBO-ICT

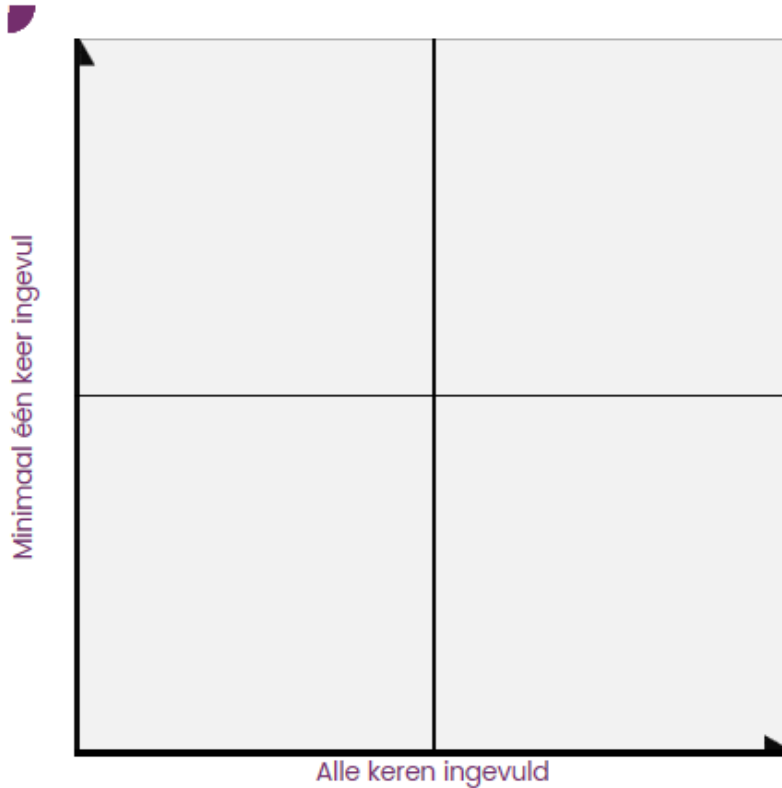

- 1 Minimaal één keer ingevuld
- 2 Alle keren ingevuld



This question is not active

Activate question

Votes: 1

2. ICT Monitor



Go to www.govote.at and use the code **27 78 18**

Hoeveel procent van de instellingen heeft IBP-beleid?

saMBO-ICT

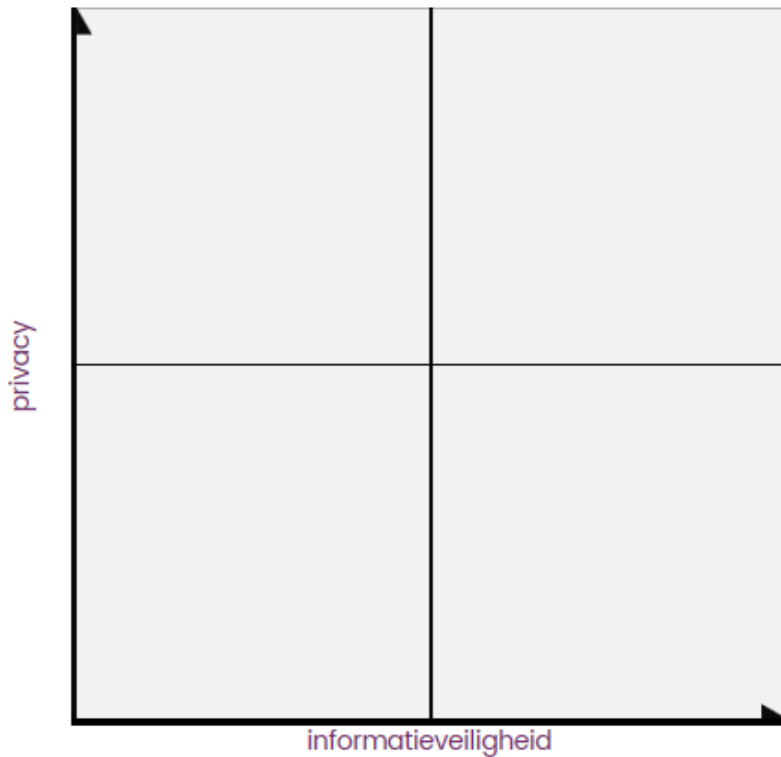

1 % met beleidsplan voor



Votes: 0

2. ICT Monitor

SURF

saMBO-ICT
Kennisnet

Go to www.govote.at and use the code **27 78 18**

Wat zijn (afgerond) de gemiddelen ict-uitgaven per deelnemer per jaar?

saMBO-ICT

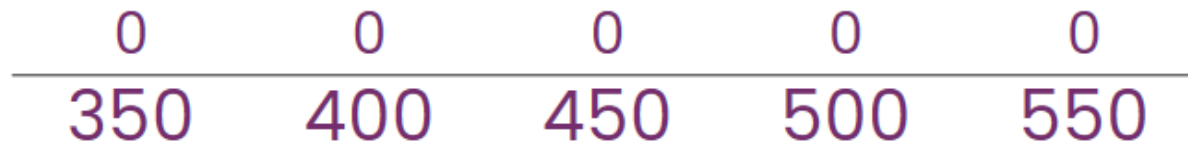

This question is not active

Activate question

Votes: 0

3. IBP



mbo referentie architectuur (IBPDO4)	Verantwoordingsdocument informatiebeveiliging en privacy in het mbo onderwijs (IBPDO1)							Privacy Compliance kader mbo (IBPDO2B)	Normenkader Informatiebeveiliging mbo (IBPDO2A)
	MBO roadmap informatiebeveiligingsbeleid en privacy beleid (IBPDO5)								
	Model Informatiebeveiligingsbeleid voor de MBO sector op basis van ISO27001 en ISO27002 (IBPDO6)				Model informatiebeveiligingsbeleid en Privacy voor de mbo sector (IBPDO18)				
	Toetsingskader IB: clusters 1 t/m 6 (IBPDO3)				Toetsingskader Privacy: cluster 7 (IBPDO7)				
	Toetsingskader Examinering Pluscluster 8 IBPDO8	Toetsingskader Online leren Pluscluster 9 IBPDO9	Toetsingskader VMBO-MBO Pluscluster 10 IBPDO10	Benchmark mbo sector IBPDO11	Functie-waardering IBP IBPDO12	Positionering IBP IBPDO13	Risico inventarisatie IBP IBPDO29		
	Handleiding BIV classificatie IBPDO14	BIV classificatie Bekostiging IBPDO15	BIV classificatie Indiensttreding IBPDO16	BIV classificatie Online leren IBPDO17	PIA Deelnemers bekostiging IBPDO19	PIA Personeel Indiensttreding IBPDO20	PIA Onderwijs Online Leren IBPDO21		
	Starterkit Identity mngt mbo versie IBPDO22	Starterkit RBAC mbo versie IBPDO23	Starterkit BCM mbo versie IBPDO24	Integriteit Code mbo versie IBPDO25	Acceptable Use Policy mbo versie IBPDO26	Responsible Disclosure mbo versie IBPDO27	Leveranciers Overeenkomst mbo versie IBPDO28		
	Implementatievoorbeelden van kleine en grote instellingen				Technische quick scan (APK) IBPDO30				
	Hoe? Zo! Informatiebeveiligingsbeleid in het mbo				en Hoe? Zo! Privacy in het mbo				
	Taskforce		IBP mbo		Voorbeelden		SCIPR		

4. KUBUS



- IaaS-dienstverlening = Virtuele Servers
 - deels eigen IaaS-diensten vanuit SURF,
 - aangevuld met IaaS-diensten van externe leveranciers
 - te beheren via een Cloud Management Platform
- Op initiatief van zes hogescholen
- Na aanbesteding beschikbaar vanaf zomer 2016 als dienst van SURF.

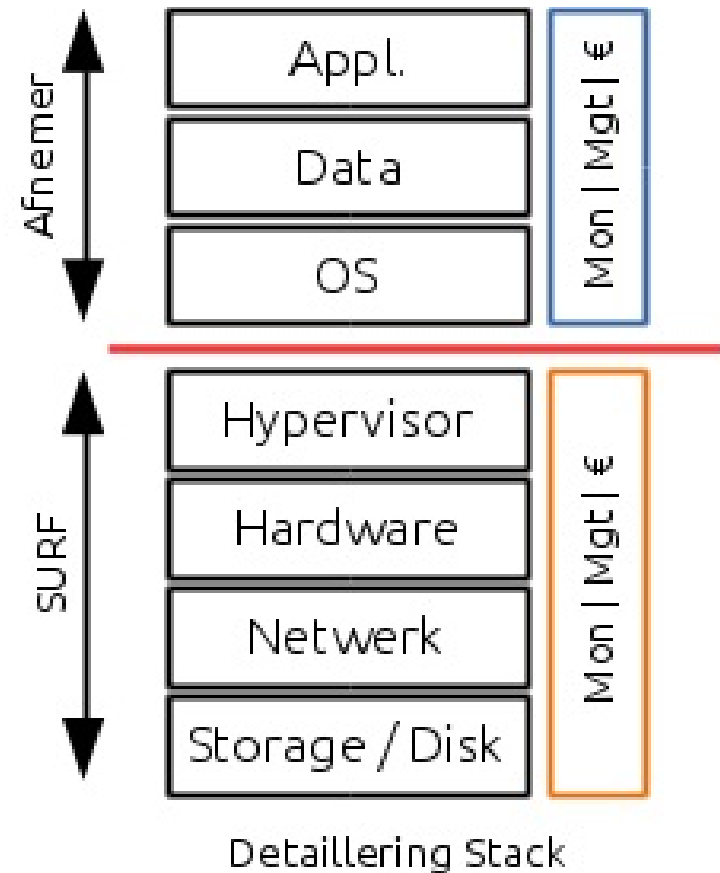

5. MBOcloud



Fasering Project

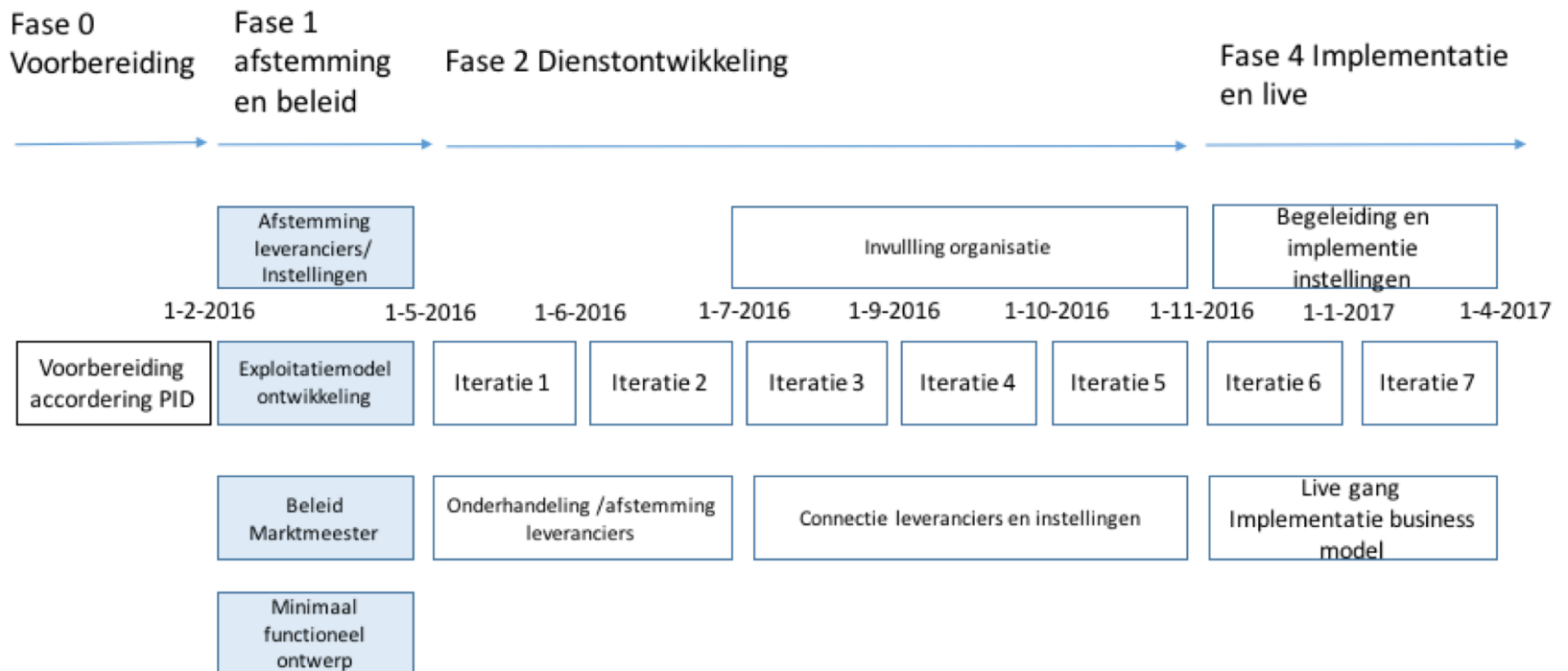

Meer weten ? <https://www.sambo-ict.nl/programmas/programma-mbocloud/>

6. Onderwijsaanbod

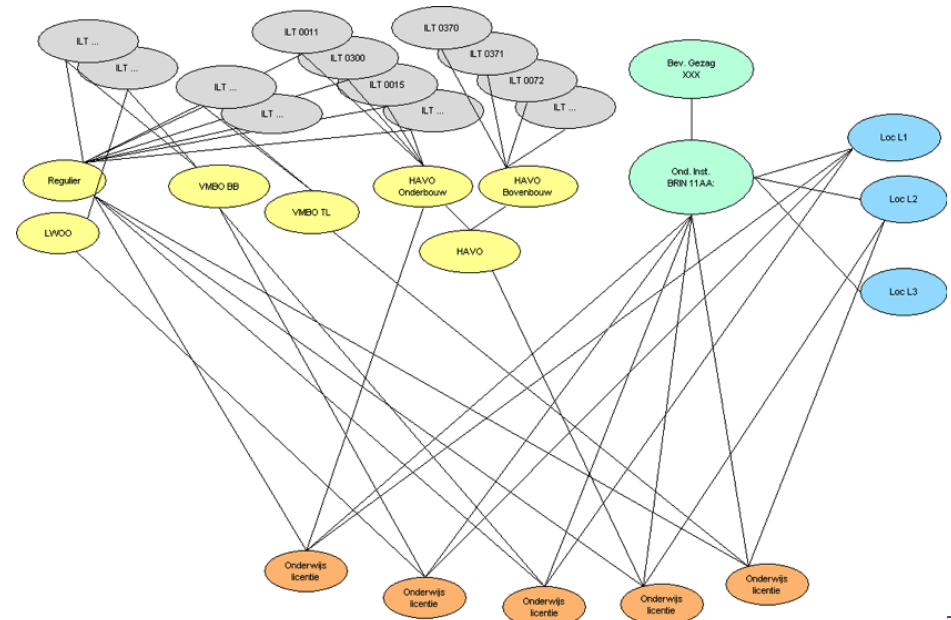
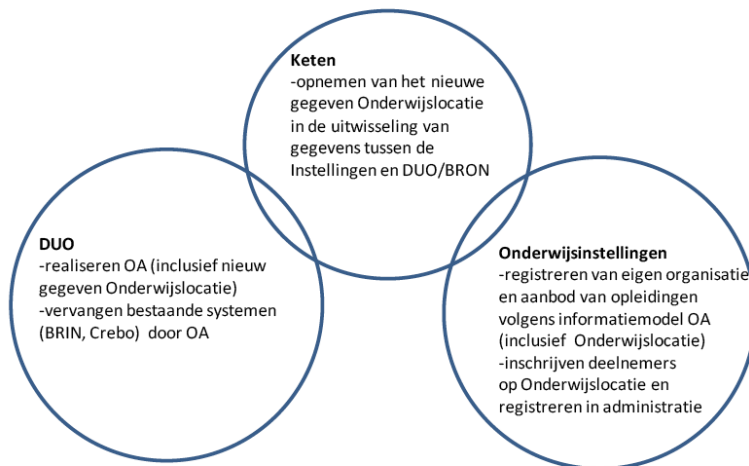
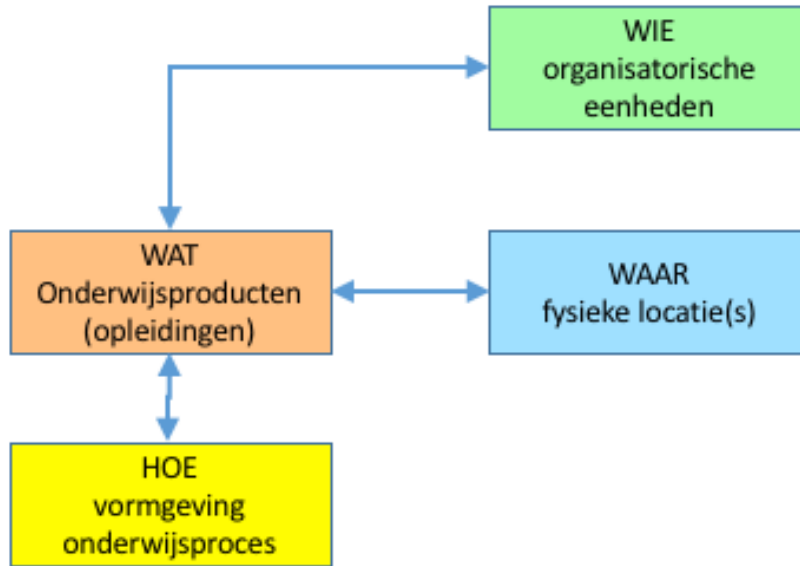

7. Modernisering BPV keten



Erkenning

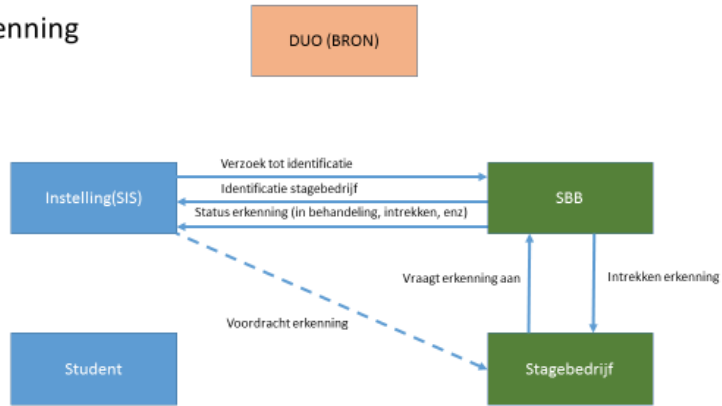

Bezetting

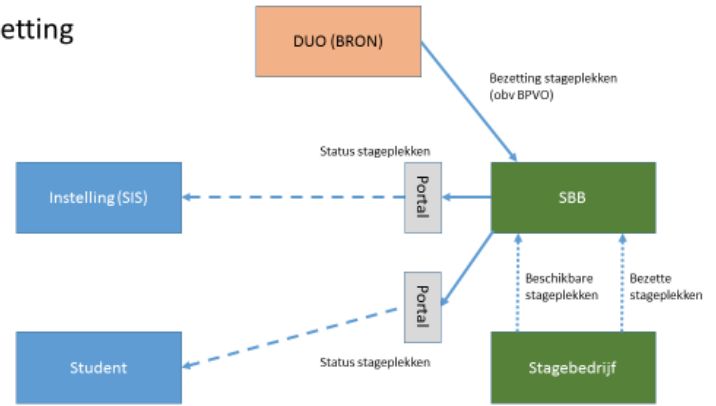

BPVO

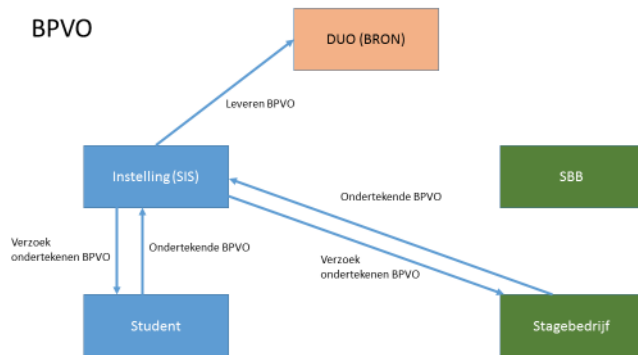

Kwaliteit BPV

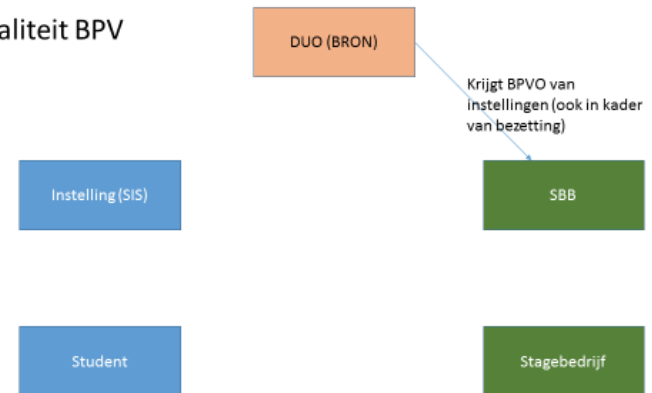

8. Vakmanschap in de 21^e eeuw



Kennisnet

A vertical menu with a blue background and white text, listing various educational institutions. Each entry includes the name of the institution and a small icon representing its field of study.

- Aventus
- Da Vinci College en de Duurzaamheidsfabriek
- Dutch HealthTec Academy (MBO Amersfoort)
- Florijn College (ROC West-Brabant)
- Mediacollege Amsterdam (Ma)
- Nordwin College
- Nova College
- ROC A12 en de Politieacademie

A photograph of a workshop scene. In the foreground, a black tablet computer lies on a dark workbench. Surrounding it are various tools: a red-handled screwdriver, a pencil, a red pencil, and a pair of pliers. In the background, there are papers with technical drawings and a stack of yellow pencils.

Vakmanschap in de 21^e eeuw
ondernemend en duurzaam beroepsonderwijs

Laat ict werken voor het onderwijs



saMBO-ICT

Kennisnet

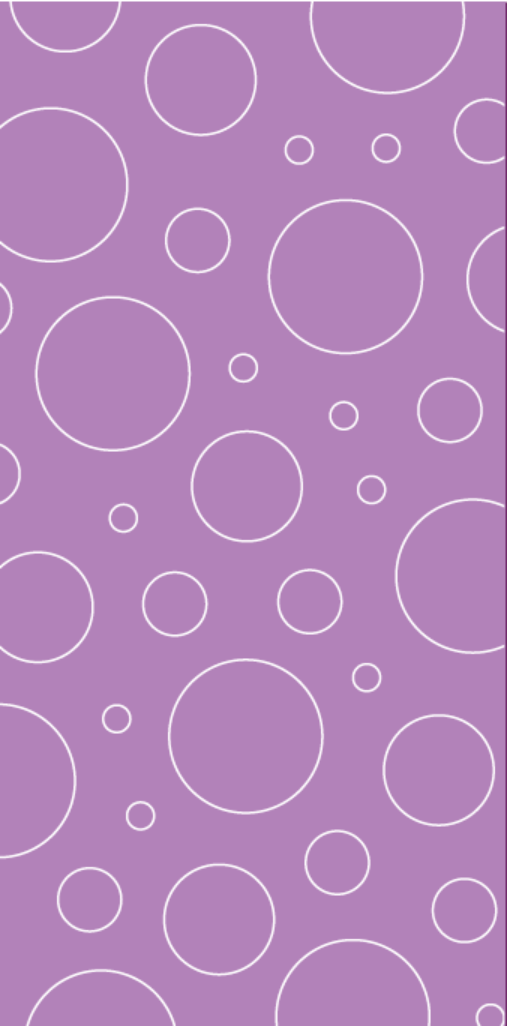

E
M